

# H300 PRODUCT DATA SHEET

With a Hydraloop unit, you can recycle up to 95% of shower & bath water and optionally 50% of washing machine water – which enables you to reuse up to 85% of the total in-house domestic water. Due to its innovative and breakthrough technology, Hydraloop water is clean, clear, safe and certified and for toilet flushing, washing machine, garden irrigation and/or swimming pool top-up.

## HYDRALOOP H300

H300	Input: Greywater from shower and bath Output: Two (2) valves for recycled greywater to the toilets and the washing machine Colour: Stone Front Plate: Stainless-steel front plate with white coloured logo and small status light
H300 Premium	Input: Greywater from shower and bath Output: Two (2) valves for recycled greywater to the toilets and the washing machine Choose from three colours: Dew, Chili and Stone Front Plate: Premium stainless-steel front plate with Hydraloop LED logo lights

## ADD-ONS

Output Garden	One (1) extra valve for recycled greywater in the garden
Output Pool	One (1) extra valve for recycled greywater for the pool
Washing Machine Option	Option to recycle 50% of greywater from washing machine, including sanitary lift pump
Lift pumps *	DAB Novabox 30/300. This lift pump is submerged underneath the floor DAB Genix VT 030. This lift pump is on the floor

\*A lift pump is only necessary if Hydraloop unit is positioned on same floor or a story higher as shower/bathtub

\*Please note that the DAB pump listed is not certified to be sold into NA

## HYDRALOOP H300 SPECIFICATIONS

Volume	300 liters / 80 gallons
Cleaning capacity	530 liters / 140 gallons per day
Dimensions	80 cm wide, 34 cm deep, 187 cm high 31.5" wide, 13.4" deep, 74" high
Voltage	100 / 240V, 24V internal
Usage	20 W during treatment. Average power consumption: 200kWh/year
WiFi	The Hydraloop unit needs to be connected with an internal WiFi-network
Average recycled greywater quality	Non-potable water: CBOD5: 6ppm TSS: 3 ppm Turbidity: 2 NTU E. coli: <1 MPN/100mL pH: 7.1
Noise Level	± 44 dB.

## LED LIGHT INDICATIONS

White	Hydraloop provides recycled greywater.
Blue	Hydraloop provides mains water (until recycled greywater becomes available).
Purple	The washing machine mode is active.
Green	In self-cleaning mode.
Orange + two (2) short sound signals per minute	The UV disinfection lamp is not functioning properly.
Red + three (3) short sound signals/minute	The water distribution pump has switched itself off. Which might happen when water is leaking somewhere in-house.

## CONNECTION OVERVIEW

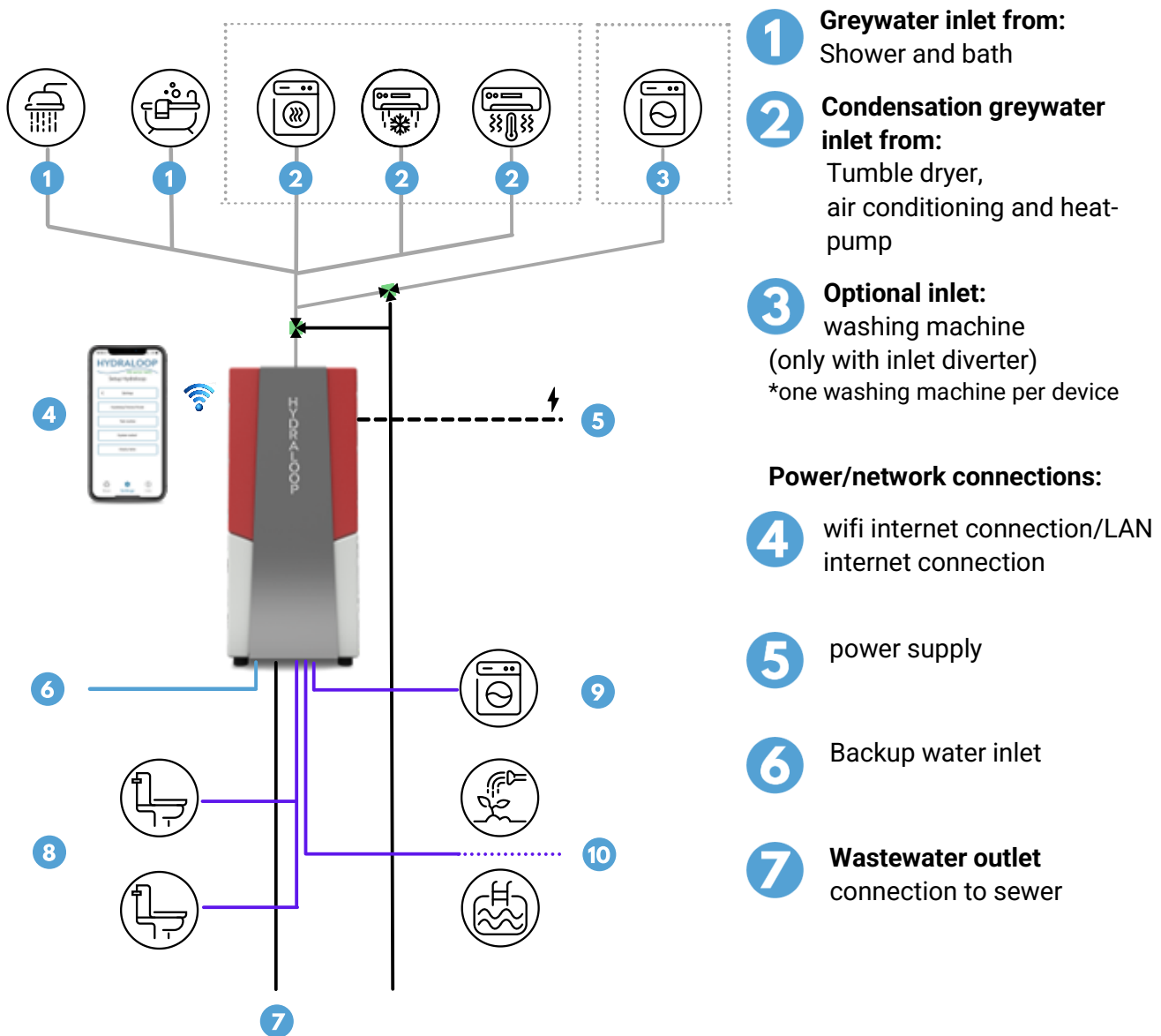

- 1 Greywater inlet from:**  
Shower and bath
- 2 Condensation greywater inlet from:**  
Tumble dryer, air conditioning and heat-pump
- 3 Optional inlet:**  
washing machine  
(only with inlet diverter)  
\*one washing machine per device

- Power/network connections:**
- 4** wifi internet connection/LAN internet connection
  - 5** power supply
  - 6** Backup water inlet
  - 7** **Wastewater outlet** connection to sewer

### Output: dedicated pipelines for

- 8** toilet flushing
- 9** washing machine
- 10** garden irrigation or swimming pool (with auxiliary outlet)

# H600 PRODUCT DATA SHEET

With a Hydraloop unit, you can recycle up to 95% of shower & bath greywater and optionally 50% of washing machine greywater – which enables you to reuse up to 85% of the total in-house domestic greywater. Due to its innovative and breakthrough technology, Hydraloop water is clean, clear, safe and certified and for toilet flushing, washing machine, garden irrigation and/or swimming pool top-up.

## HYDRALOOP H600

H600	Input: Greywater from shower and bath Output: Two (2) valves for recycled greywater to the toilets and the washing machine Colour: Stone Front Plate: Stainless-steel front plate with white coloured logo and small status light
H600 Premium	Input: Greywater from shower and bath Output: Two (2) valves for recycled greywater to the toilets and the washing machine Choose from three colours: Dew, Chili and Stone Front Plate: Premium stainless-steel front plate with Hydraloop LED logo lights

## ADD-ONS

Output Garden	One (1) extra valve for recycled greywater in the garden
Output Pool	One (1) extra valve for recycled greywater for the pool
Lift pumps *	DAB Novabox 30/300. This lift pump is submerged underneath the floor DAB Genix VT 030. This lift pump is on the floor

\*A lift pump is only necessary if Hydraloop is positioned on same floor or a story higher as shower/bathtub.

\*Please note: DAB pump listed above is not certified in NA

## HYDRALOOP H600 DUAL SPECIFICATIONS

Volume	600 L / 160 gallons
Cleaning capacity	1000 L / 260 gallons per day
Dimensions	80 cm wide, 69 cm deep, 187 cm high 31.5" wide, 27.5" deep, 74" high
Voltage	100/240 V, 24V internal
Usage	40 W during treatment Average power consumption: 350 kWh/year
WiFi	The Hydraloop unit needs to be connected to internet with a WiFi-network
Average recycled water quality	Non-potable water CBOD5: < 10 ppm TSS: <10 ppm Turbidity: NTU E. coli: < 14 pH: 6.0 – 9.0
Noise Level	± 46 dB.

## LED Light Indications

White	Hydraloop provides recycled greywater.
Blue	Hydraloop provides mains water (until recycled greywater becomes available).
Purple	The washing machine mode is active.
Green	In self-cleaning mode.
Orange + two (2) short sound signals per minute	The UV disinfection lamp is not functioning properly.
Red + three (3) short sound signals/minute	The water distribution pump has switched itself off. Which might happen when water is leaking somewhere in-house.

## CONNECTION OVERVIEW

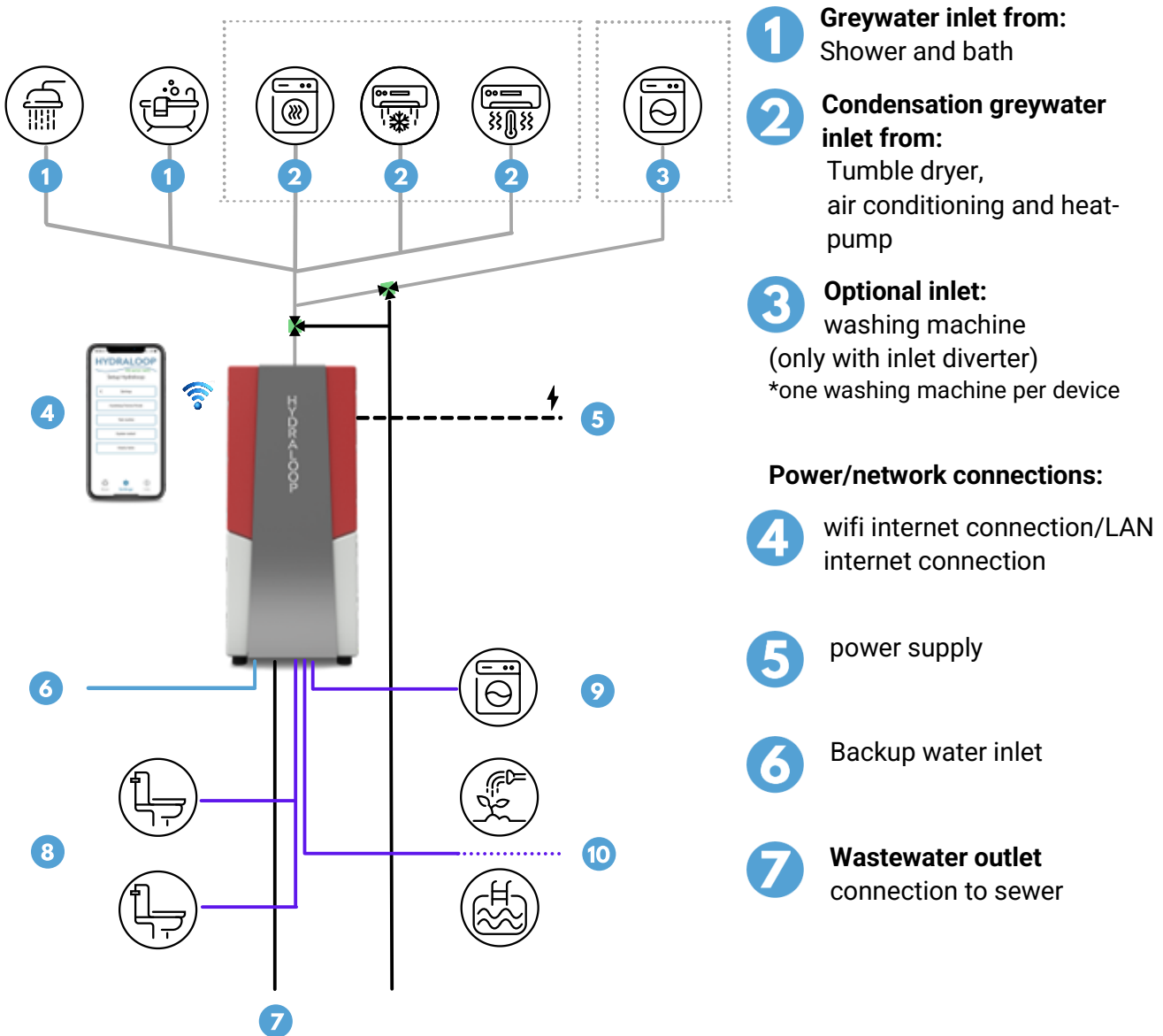

### Output: dedicated pipelines for

- 8** toilet flushing
- 9** washing machine
- 10** garden irrigation or swimming pool (with auxiliary outlet)

# HYDRALOOP® **Hydraloop Cascade Product Data Sheet**

USE WATER TWICE



With the scalable and made to measure Hydraloop Cascade system, you can recycle up to 95% of in-house water. A Hydraloop Cascade can treat and redistribute greywater from shower, bath, hand basins, and optionally washing machine (only with WMR option) as well as condensation water from tumble dryer, heat pump, and air conditioning. Due to its innovative and breakthrough technology, Hydraloop water is clean, clear, safe and certified. You can reuse it for toilet flushing, washing machine, garden irrigation and/or swimming pool top-up. The maintenance requirements and corresponding costs are very low.













The Hydraloop Cascade can be assembled by configuring two or more Hydraloop units in cascade arrangement. Depending on the building and the application, one central location can be chosen in the building for one cascade configuration. Or several locations with 2 or more compact cascade configurations.

Each Hydraloop unit in the cascade set up works independently in the cleaning process. The treated and disinfected recycled water is stored in one volume which is formed by the interconnected individual water storage tanks of the Hydraloop units. Treatment and storage tanks form one integral cluster. A powerful booster pump distributes the recycled water in the building to be used for toilet flushing and garden irrigation. In case of a temporary shortage of recycled water, the system automatically switches to its back-up water source like tap water or rainwater.

An online information system is available for real-time status information and performance.

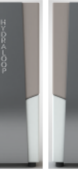
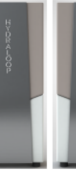

## EXAMPLE: HYDRALOOP CASCADE 14 DURING 3-MONTH PERIOD

													
Unit 01	Unit 02	Unit 03	Unit 04	Unit 05	Unit 06	Unit 07	Unit 08	Unit 09	Unit 10	Unit 11	Unit 12	Unit 13	Unit 14
Online	Online	Online	Online	Online	Online	Online	Online	Online	Online	Online	Online	Online	Online
previous month 2929 total 6395	previous month 2276 total 5364	previous month 4005 total 9125	previous month 5163 total 18158	previous month 3787 total 8723	previous month 4036 total 9543	previous month 5205 total 11468	previous month 3910 total 11746	previous month 5928 total 15237	previous month 5203 total 14659	previous month 6153 total 19306	previous month 6989 total 20847	previous month 6559 total 19040	previous month 6679 total 18857

Total 188468 liters water recycled

### Hydraloop Cascade

Input	<ul style="list-style-type: none"> <li>- greywater from shower, bath, hand basins, and optionally washing machine (only with WMR option)</li> <li>- condensation water from tumble dryer, heat pump, and air conditioning</li> </ul> <p>Hydraloop Cascade cannot collect greywater from the washing machine.</p>
Output	1 outlet for recycled water for each Hydraloop cluster for toilet flushing and irrigation.
Colour	Stone
Front Plate	Stainless-steel front plate with white coloured logo and status light.

### Hydraloop Specifications

Treatment capacity	<p>Scalable from 1060 liters   280 gallons per day up to 10,600 liters   2800 gallons per cluster</p> <p>Multiple Hydraloop Cascade clusters can be installed</p>
Voltage	100   240 Volt, 24 Volt internal
Internet	The Hydraloop unit needs to be connected with an internet connected (wifi) network
Noise Level	Depending on the size of the installation

## Schematic overview

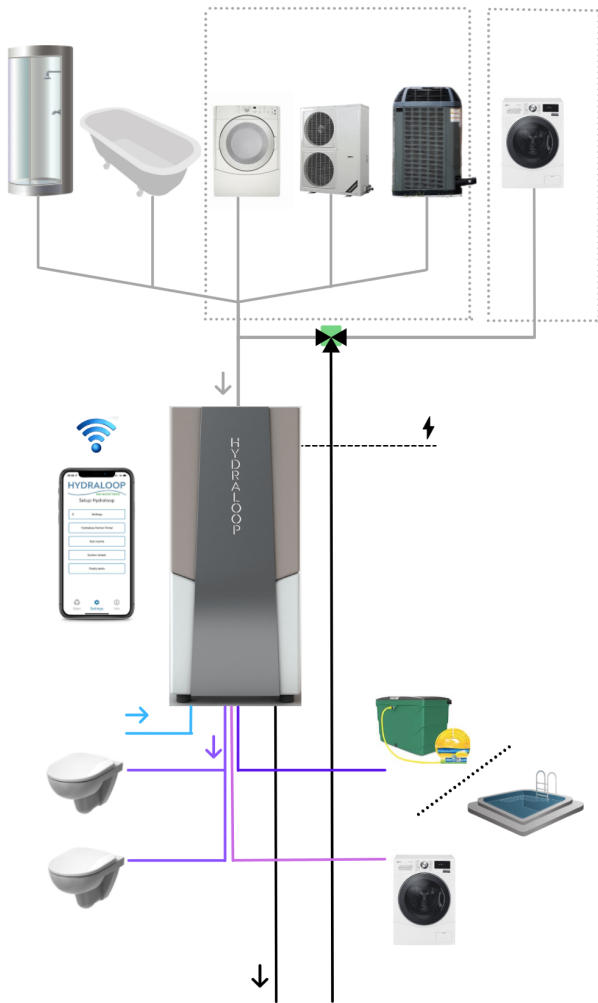

### Inlet to Hydraloop

- greywater from shower, bath, hand basins, and optionally washing machine (only with WMR option)
- condensation water from tumble dryer, heat pump, and airconditioning

### Power/network connections

- power supply
- wifi internet connection

### Treated greywater output dedicated lines for

- toilet flushing
- washing machine
- garden irrigation or swimming pool

### Backup water inlet

- tap water or filtered rainwater

### Wastewater outlet

- connection to sewer



Certified to NSF/ANSI Standard 350

The NSF/ANSI 350 standard verifies that all design and performance requirements of the standard have been met, and confirms through testing that effluent reuse water meets the stringent quality criteria. The NSF/ANSI 350 standard also sets water quality requirements for the reduction of chemical and microbiological contaminants for non-potable water use.

During the 26-week NSF/ANSI 350 testing period, the Hydraloop product was dosed daily with a greywater mix that contained raw wastewater, secondary effluent, body wash, shampoo, conditioner, soap, toothpaste, deodorant, bath cleaner, lactic acid, liquid handsoap, laundry detergent & softener, Na<sub>2</sub>SO<sub>4</sub>, NaHCO<sub>3</sub>, Na<sub>3</sub>PO<sub>4</sub> and test dust. The incoming greywater and the treated recycled water was lab tested for 26 weeks, typically 3 days a week.

**Influent values of the incoming greywater used for the 26 week test**

Parameters	Required range
TSS (mg/L)	50 - 160 mg/L
BOD <sub>5</sub>	130 - 210 mg/L
Temperature	25 - 35 Celcius
pH (SU)	6.0 - 8.5
Turbidity	30 - 100 NTU
Total phosphorous-P	1.0 - 3.0 mg/L
Total Kjeldahl -N	3.0 5.0 mg/L
COD	250 - 400 mg/L
Total coliforms	10 <sup>3</sup> - 10 <sup>7</sup> cfu/100 mL
E.coli	10 <sup>2</sup> - 10 <sup>6</sup> cfu/100 mL

**Effluent values NSF-350 requirements and Hydraloop treated water test results**

NSF/ANSI 350 requirements	HYDRALOOP average results
BOD <sub>5</sub> (mg/L)	< 10 BOD <sub>5</sub> (mg/L) 6
TSS (mg/L)	< 10 TSS (mg/L) 3.3
Turbidity (NTU)	< 5 Turbidity (NTU) 2.3
E. coli (MPN/100mL)	< 14 E. coli (MPN/100mL) < 1
pH (SU)	6.0 - 9.0 pH (SU) 6.0 - 9.0

The Hydraloop product supplied recycled water with a quality that falls well within the parameters of the requirements as set by the NSF/ANSI 350 standard.

Hydraloop treated water can be used for applications such as toilet and urinal flushing, laundry machine, irrigation, and other non potable applications.

The Hydraloop product did not require any user maintenance during the 26-week testing period.

Visit the NSF website for the [listing](#) of Hydraloop products.

Hydraloop Systems B.V.  
Wetuis Building, Water Campus  
Oostergoweg 9, 8911 MA Leeuwarden  
The Netherlands  
+31 88 100 3500

Global Water Center, 247 W.  
Freshwater Way, Suite 210  
Milwaukee, WI 53202  
USA  
+1 414 89 500 21

## NSF International

789 N. Dixboro Road, Ann Arbor, MI 48105 USA

RECOGNIZES

Hydraloop Systems B.V.  
The Netherlands

AS COMPLYING WITH NSF/ANSI 350 AND ALL APPLICABLE REQUIREMENTS.  
PRODUCTS APPEARING IN THE NSF OFFICIAL LISTING ARE  
AUTHORIZED TO BEAR THE NSF MARK.



This certificate is the property of NSF International and must be returned upon request. This certificate remains valid as long as this client has products in Listing for the referenced standard. For the most current and complete Listing information, please access NSF's website ([www.nsf.org](http://www.nsf.org)).

November 4, 2020  
Certificate# C0427542 - 01

Stefan Bueck  
General Manager, Water Systems



## Safety certificate K102335/02

Issued 2021-11-15  
Replaces K102335/01  
Page 1 of 3



## Water recycling system

STATEMENT BY KIWA  
With this safety certificate, issued in accordance with the Kiwa Regulations for Certification, Kiwa declares that legitimate confidence exists that the products supplied by

### Hydraloop International B.V.

comply with the technical specifications as laid down in this safety certificate and are marked with the Kiwa®-mark as specified in this safety certificate are, on delivery, relied upon to comply with Kiwa evaluation guideline

**BRL-K14011/01** "Aspects of technical water supply protection for appliances with a contamination risk" dated 2019-06-27,

wherein the requirements of

**EN 1717: 2000** "Protection against pollution of potable water in water installations and general requirements of devices to prevent pollution by backflow".

are applied for analysing the risk of contamination by backflow and for selecting the appropriate backflow prevention unit(s).

Ron Scheepers  
Kiwa

Publication of this certificate is allowed.  
Advice: consult [www.kiwa.nl](http://www.kiwa.nl) in order to ensure that this certificate is still valid.

Kiwa Nederland B.V.  
St Winston Churchilllaan 273  
Postbus 70  
2280 AB RUSWIJK  
The Netherlands  
Tel: +31 88 996 44 00  
Fax: +31 88 996 44 20  
NL: [Kiwa.info@Kiwa.com](mailto:Kiwa.info@Kiwa.com)  
[www.kiwa.nl](http://www.kiwa.nl)

Supplier  
Hydraloop International B.V.  
Water Campus Leeuwarden  
Agora 4  
8924 GJ LEEUWARDEN  
Tel: +31 881003500  
[info@hydraloop.com](mailto:info@hydraloop.com)  
[www.hydraloop.com](http://www.hydraloop.com)

For more information, please visit [www.hydraloop.com](http://www.hydraloop.com)

