

Micor Technologies

Power&Mobility

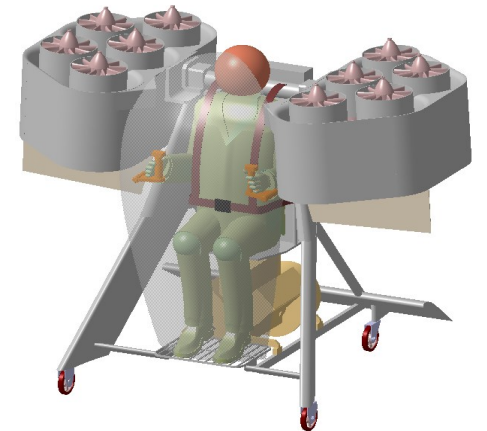

Multi-Fuel Wankel Range Extender

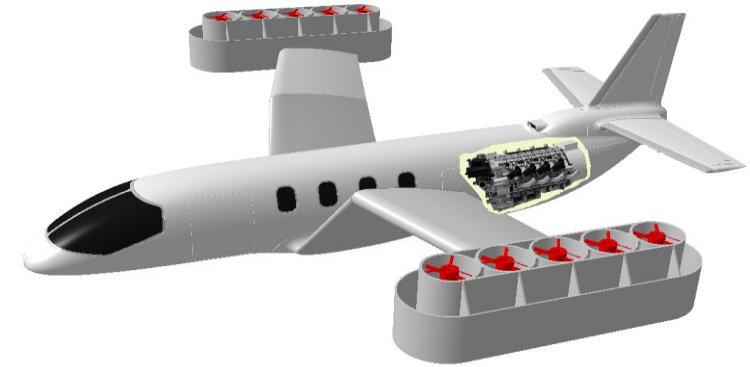
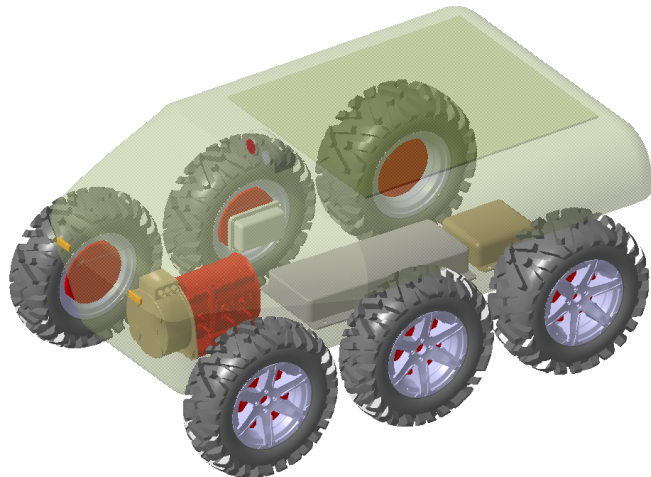

Hybrid-Electric Powertrain for Terrestrial Vehicles

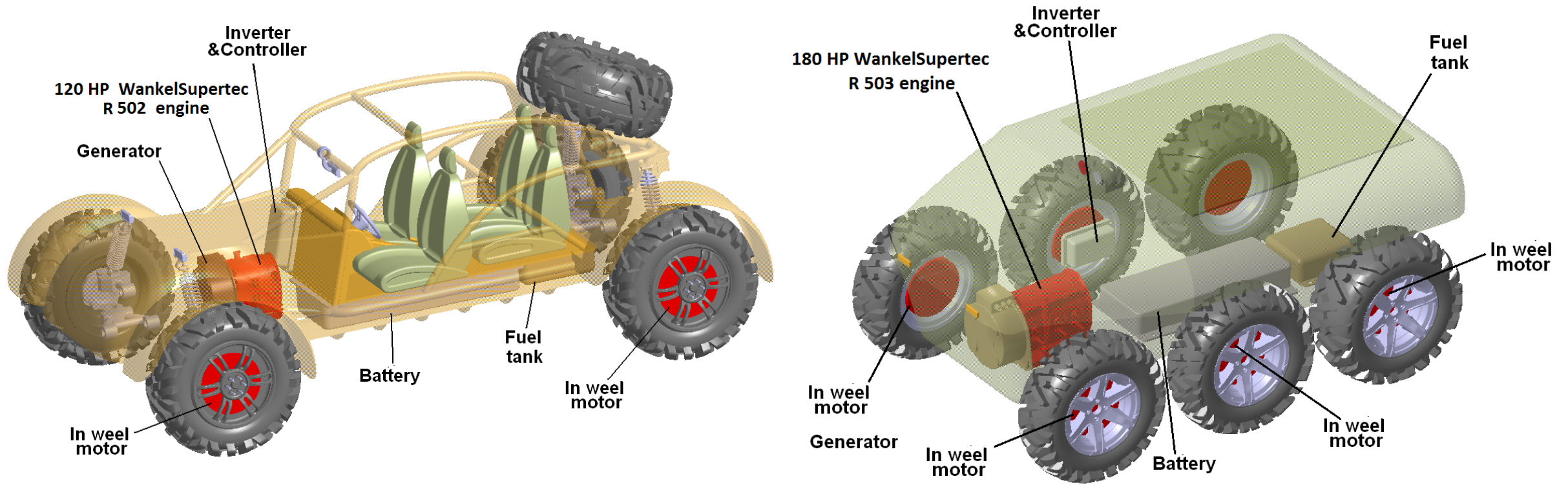

Hybrid-Electric Powertrain for CTOL/VTOL Aircraft

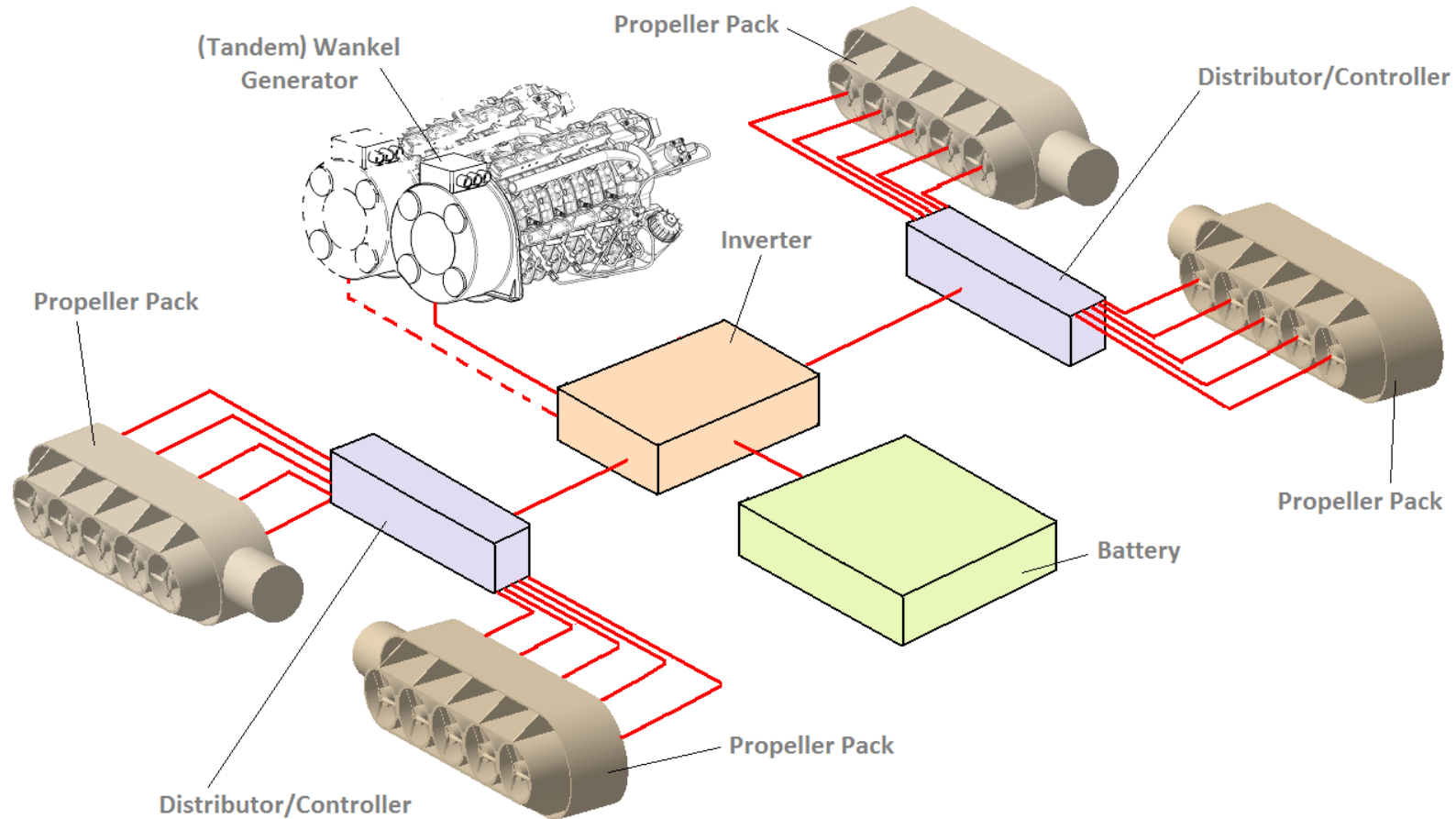

New Propulsion Systems for VTOL /WIG Aerial Vehicles with Thrust Augmenters

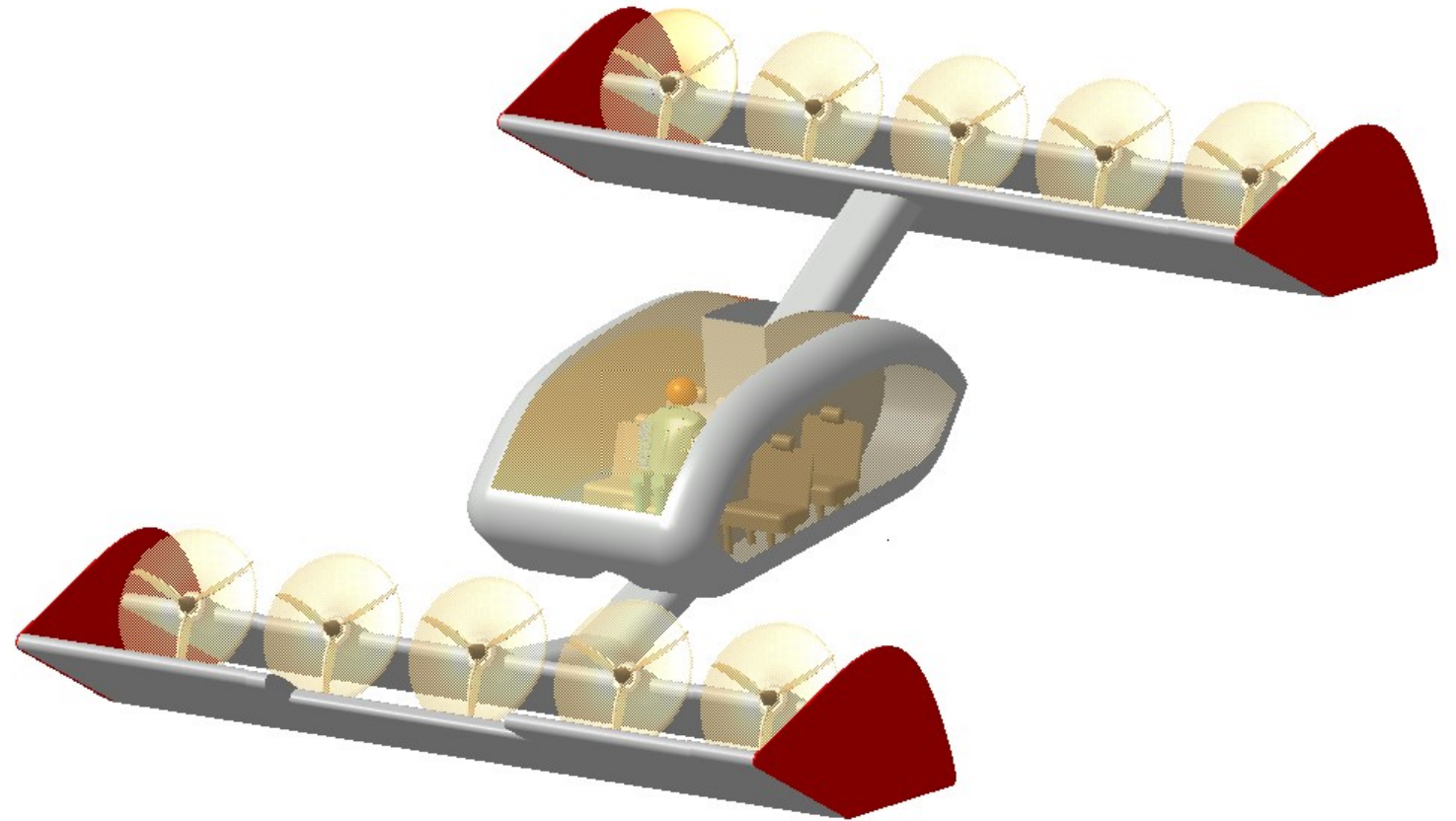
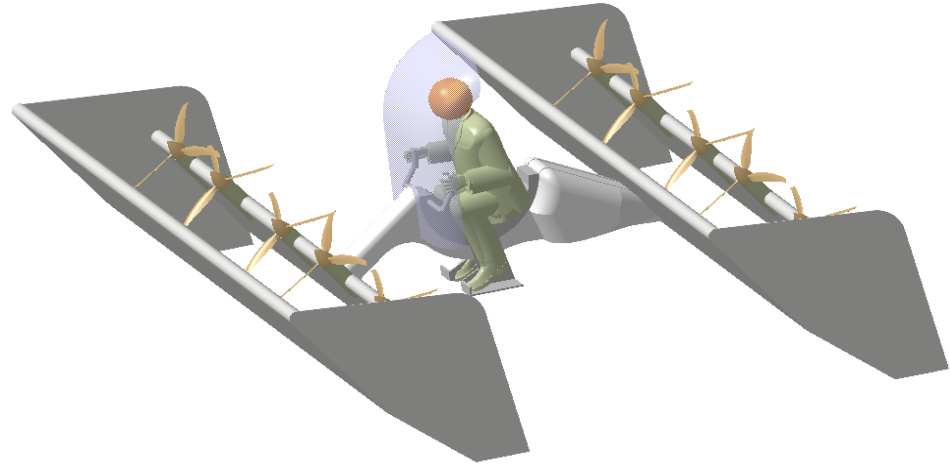

New Propulsion Systems for STOL/VTOL Aircraft with Standard Fuselage (most cost effective solution)

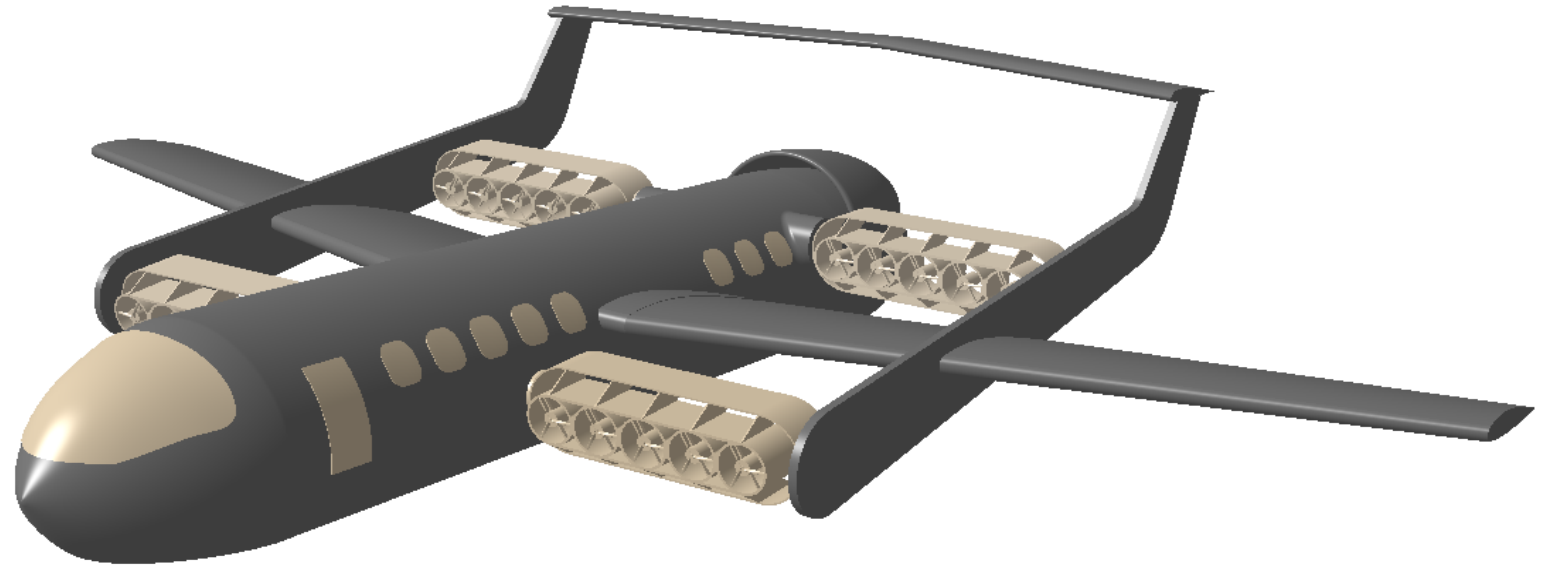

High speed VTOL Aircraft with Thrust Augmenter

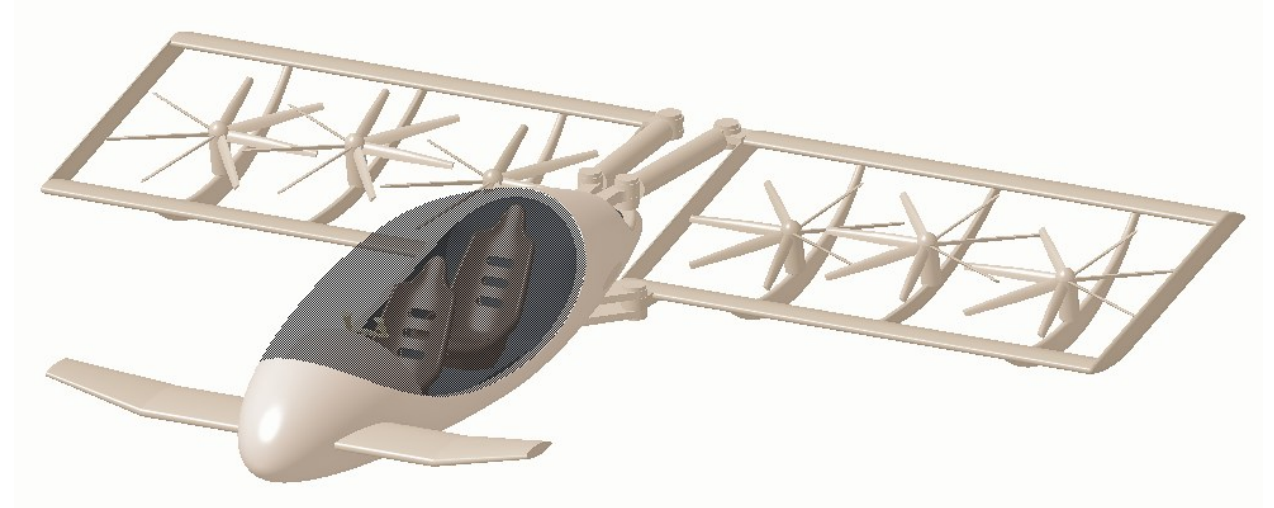
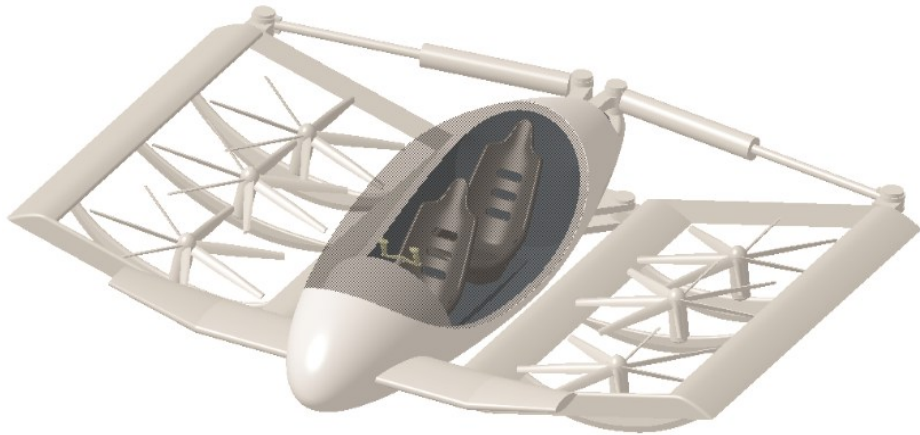

New VTOL-UAV propulsion systems and configurations

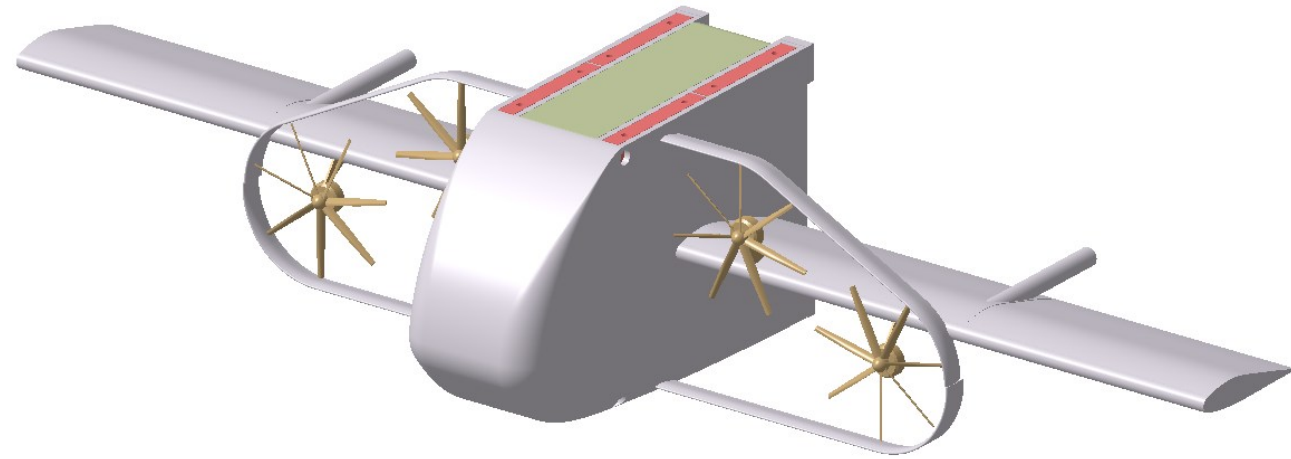
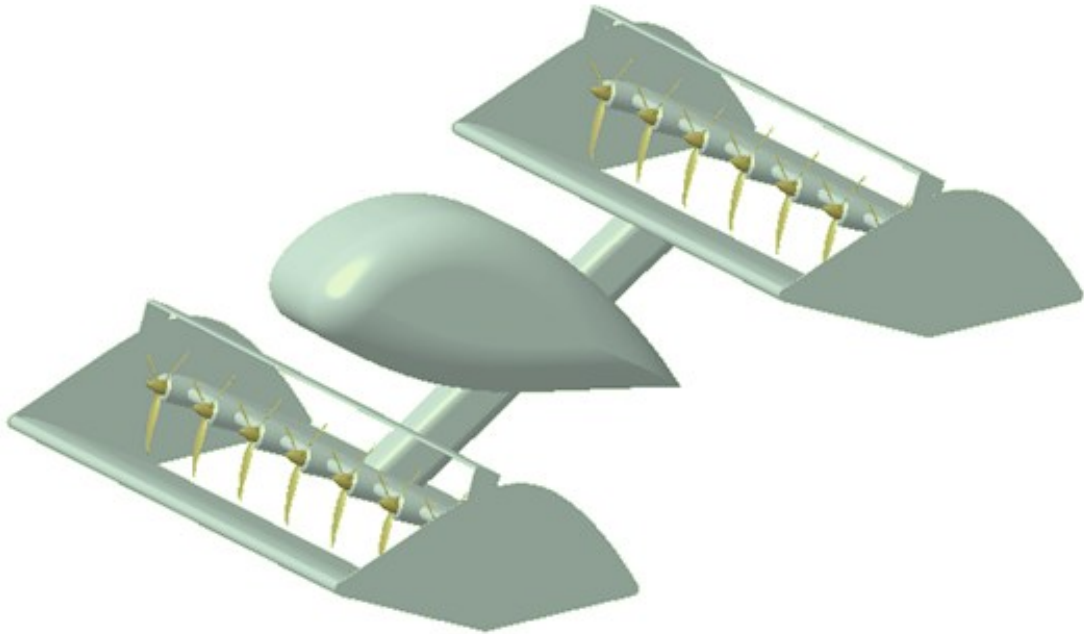

Coandă Effect VTOL/WIG vehicles with boundary layer control

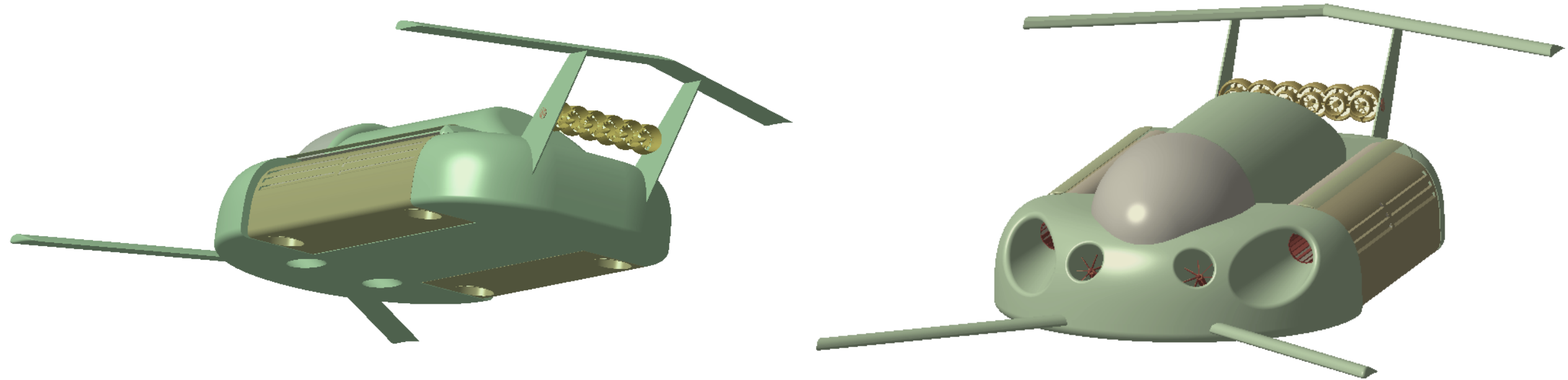

Ultra-compact Personal VTOL Aircraft (type GoFly contest)

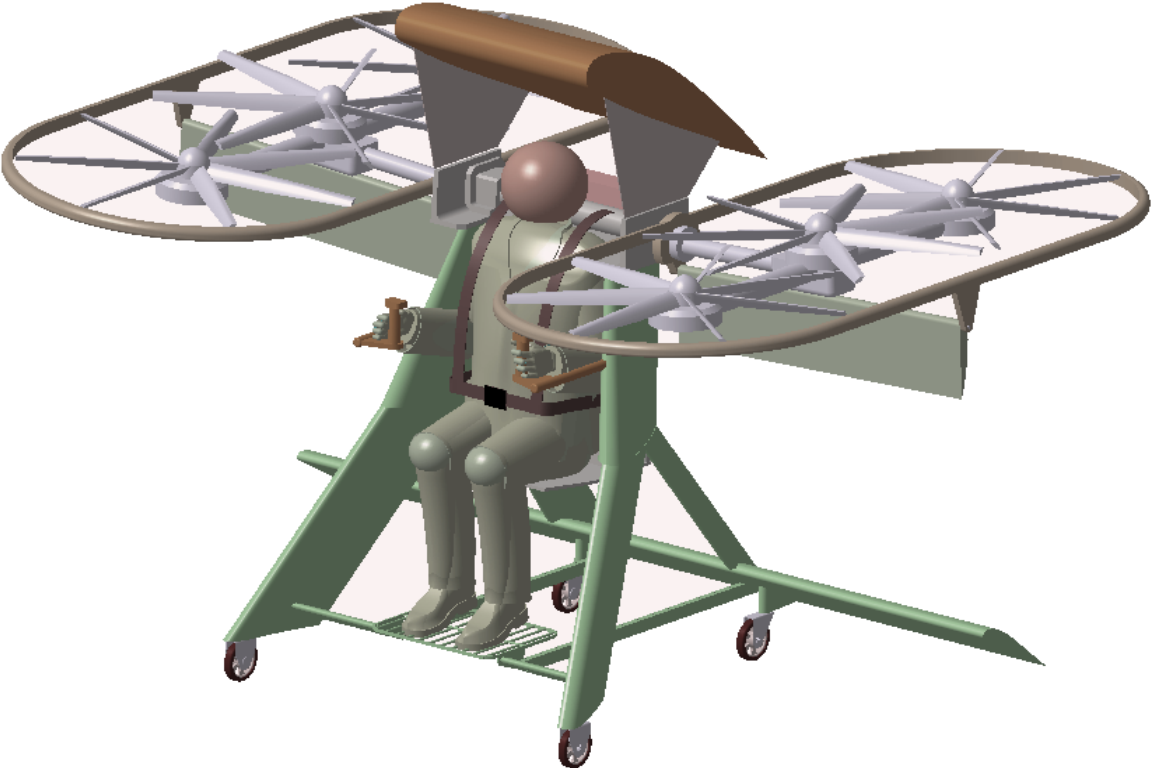
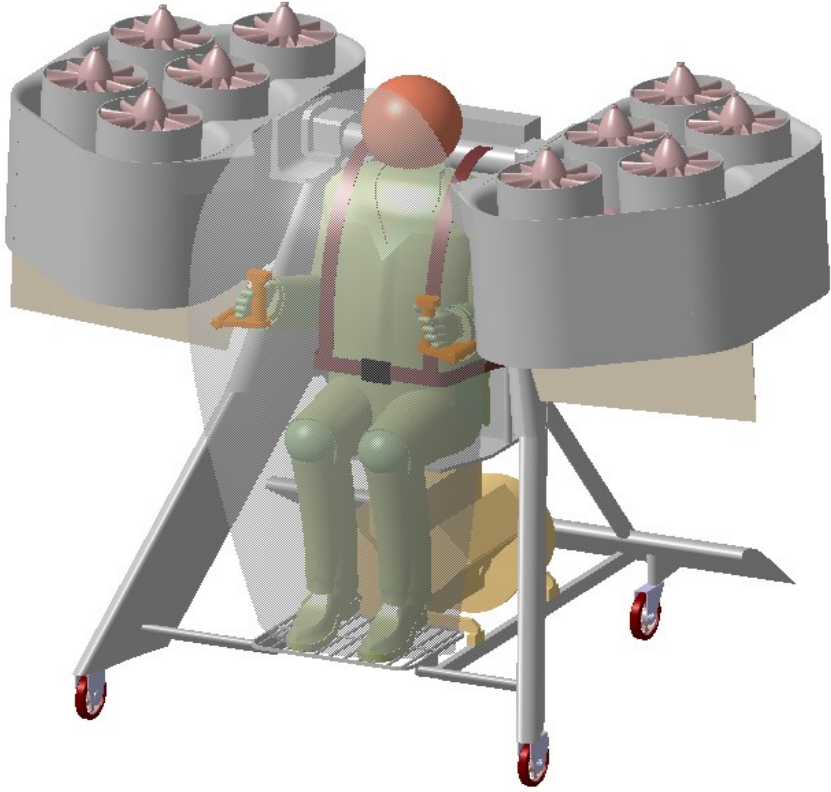

Contact Micor Technologies

marketing@micortec.com

liviugiurca@micortec.com , michaelsanmar@micortec.com

**3664, Henry St
Norton Shores, MI 49441**

**Phone: +12312068140
+40731015778**